

AS950 ALL-WEATHER REFRIGERATED SAMPLERS

Sampling has never been this easy.

The AS950 All-Weather Refrigerated Sampler makes programming, data transfer and operation more intuitive and virtually error-free.



Applications

- Wastewater
- Collections
- Industrial Pretreatment
- Environmental Monitoring
- Stormwater

Easiest and Most Intuitive Operation

The large full color display and intuitive programming give you access to all your programmable criteria on a single screen—eliminating scrolling through menus and supporting error-free operation.

Most Convenient Data Transfer and Programming Available

The AS950 is the only sampler that utilizes a USB drive to upload and download data and copy programs from one sampler to another.

Confidence in Your Sampling Process

The program status screen instantly communicates alarms, missed samples and program progress for quick and easy troubleshooting.

Resists Corrosion

The All Weather Refrigerated (AWR) sampler base is designed to endure humid and highly corrosive environments, minimizing damage caused by corrosive gases, rodents, and standing water to guarantee environmental integrity.

Accurate and Consistent Sample Preservation

The custom-designed air-sensing thermostat controls temperature in accordance with USEPA and international guidelines, preserving samples regardless of outside temperatures and conditions.

Easy Maintenance at Low Cost

Spring-mounted rollers provide long tubing life keeping maintenance costs low. The desiccant and pump tubing can easily be accessed; the replacement is possible without any tools. The rugged see-through pump cover is made for a quick visual inspection.



Be Right™

Specifications*

Sampling Features

Dual Programs

Up to 2 sample programs can be run sequentially, in parallel, or according to day of week scheduling; enabling a single sampler to function like multiple samplers

Sampling Modes

Pacing:

Time Weighted, Flow Weighted, Time Table, Flow Table, Event

Distribution:

Single bottle composite, multi-bottle composite, multi-bottle discrete, bottles per sample, samples per bottle or a combination of bottles per sample and samples per bottle

Run Modes

Continuous or non-continuous

Status Screen

Communicates what program is running, if there are any missed samples, when the next sample will be taken, how many samples remain, number of logged channels, time of last measurement, memory available, number of active channels, if alarms were triggered, when alarms were triggered, active sensors and cabinet temperature

Alarms

Configurable alarms that show on status screen and are recorded in diagnostics alarm logs. Alarms can be set for system diagnostics and logging such as program end, sample complete, missed samples and full bottle. Channel alarms are setpoint alarms for the recorded measurements (channels), such as pH, level and power supply voltage.

Manual Sample

Initiates a sample collection independent of program in progress

Automatic Shutdown

Multiple Bottle Mode: After complete revolution of distributor arm (unless Continuous Mode is selected)

Composite Mode: After preset number of samples have been delivered to composite container, from 1 to 999 samples, or upon full container.

Sample Volume

Programmable in 10-mL (0.34 oz) increments from 10 to 10,000 mL (3.38 oz to 2.6 gal)

Interval Between Samples

Selectable in single increments from 1 to 9,999 flow pulses (momentary contact closure 25 ms or 5 to 12 Vdc pulse; 4-20 mA interface optional), or 1 to 9,999 minutes in one minute increments

Set Point Sample Trigger

When equipped with flow sensor or pH/temperature sensor or peripheral monitoring options, sampling can be triggered upon an upset condition when field selectable limits are exceeded

Datalogging

SAMPLE HISTORY

Stores up to 4000 entries for sample time stamp, bottle number and sample status (success, bottle full, rinse error, user abort, distributor error, pump fault, purge fail, sample timeout, power fail and low main battery)

MEASUREMENTS

Stores up to 325,000 entries for selected measurement channels in accordance with the selected logging interval

EVENT LOG

Stores up to 2000 entries. Records Power On, Power Fail, Firmware Updated, Pump Fault, Distributor Arm Error, Low Memory Battery, Low Main Battery, User On, User Off, Program Started, Program Resumed, Program Halted, Program Completed, Grab Sample, Tube Change Required, sensor communication errors, cooling failed, heating failed, thermal error corrected

Diagnostics

View event and alarm logs as well as maintenance diagnostics

**Subject to change without notice.*

Specifications*

AS950 All Weather Refrigerated Sampler (AWRS)

Cabinet	IP24, low-density polyethylene with UV inhibitor
Refrigeration components and copper plumbing	Corrosion protected with conformal coating; all exposed copper tubing is insulated to avoid sweating and condensation
Sample Cooling	<p>Top mounted compressor and fan-forced air cooled condenser</p> <p>11/5 HP</p> <p>115 VAC: 115 °C (239 °F) thermal overload protector, 7.1 locked rotor amps</p> <p>230 VAC: 120 °C (248 °F) thermal overload protector, 7.6 A peak start current</p> <p>3-sided wraparound plate type evaporator</p> <p>Rigid foam insulation: 3 in. sides, 5 in. top, 6 in. bottom</p> <p>Lockable lid to prevent tampering with programming</p> <p>Recovery Time: Sampler temperature recovers to 4°C within 5 minutes after door has been held open for one minute in 24°C (75°F) ambient environment while in an active cooling cycle.</p> <p>Pull Down Time: From 24°C (75°F) to 4°C (39°F), 20 minutes</p> <p>Temperature Control: 4 (±0.8) °C (39 (±1.5) °F)¹</p>
Sample Containers	<p>SINGLE BOTTLE: 10 L (2.5 gal) glass or polyethylene, or 21 L (5.5 gal) polyethylene</p> <p>MULTIPLE BOTTLES: Two 10 L (2.5 gal) polyethylene or glass, four 10 L (2.5 gal) polyethylene or glass, eight 2.3 L (0.6 gal) polyethylene or 1.9 L (0.5 gal) glass, twelve 2 L (0.5 gal) polyethylene, twenty-four 1 L (0.3 gal) polyethylene or 350 mL (12 oz.) glass</p>
Installation category, pollution degree	II, 2
Temperature	<p>Operating: 0 to 50 °C (32 to 122 °F); with AC battery backup: 0 to 40 °C (32 to 104 °F) with controller compartment heater: -40 to 50 °C (-40 to 122 °F); with controller compartment heater and AC battery backup: -15 to 40 °C (5 to 104 °F)</p> <p>Liquid Crystal Display (LCD): -10 to 70°C (-14 to 158°F)</p> <p>Storage: -40 to 60°C (-40 to 140°F)</p>

Power Requirements (includes compressor)	<p>115 VAC, 60 Hz, 4.2 A or 6.4 A with controller compartment heater</p> <p>230 VAC, 50 Hz, 2.7 A or 4.1 A with controller compartment heater</p> <p>Overload Protection: 115 VAC: 7.5 A circuit breaker 230 VAC: 5.0 A circuit breaker</p>
AC Power Backup (Pump Controller Only)	<p>Rechargeable 6 amp-hour gel lead acid battery takes over automatically with AC line power failure</p> <p>Integral trickle charger maintains battery as full charge</p>
Dimensions (W x D x H)	76 x 81 x 130 cm (30 x 32 x 51 in.)
Weight	86 kg (190 lb)
Certifications	CE, UL, CSA

AS950 Controller

Housing	PC/ABS blend, NEMA 4X, 6, IP68, corrosion and ice resistant
Graphics Display	1/4 VGA, Color; self-prompting/menu-driven program
User Interface	Membrane switch keypad with 2 multiple function soft keys
Program Languages	Chinese, English, French, German, Italian, Spanish, Portuguese
Program Lock	Access code protection prevents tampering
Memory	Sample history: 4000 records; Data log: 325,000 records; Event log: 2000 records
Communications	USB and optional RS485 (Modbus)
AUX port inputs	One 0/4-20 mA input for flow pacing
Certifications	CE, UL

*Subject to change without notice.

Specifications*

Sample Pump and Strainer

Sample Pump

High-speed peristaltic, dual roller, with 0.95 ID x 0.16 OD cm (3/8 ID x 5/8 in. OD) pump tube

Pump Body

IP37, polycarbonate cover

Vertical Lift

8.5 m (28 ft) using 8.8 m (29 ft) maximum of 3/8-in vinyl intake tube at sea level at 20 to 25 °C (68 to 77 °F)

Tubing

Pump tubing:

9.5 mm ID x 15.9 OD mm (3/8-in ID x 5/8-in. OD) silicone

Intake tubing: 1.0 to 4.75 m (3.0 to 15.5 ft) minimum length, ¼-in. or 3/8-in. ID vinyl or 3/8-in. ID Teflon®-lined polyethylene with protective outer cover (black or clear)

Sample Volume Repeatability (typical)

±5% of 200 mL sample volume with: 4.6 m (15 ft) vertical lift, 4.9 m (16 ft) of 3/8- in vinyl intake tube, single bottle, full bottle shut-off at room temperature and 1524 m (5000 ft) elevation

Sample Volume Accuracy (typical)

±5% of 200 mL sample volume with: 4.6 m (15 ft) vertical lift, 4.9 m (16 ft) of 3/8- in. vinyl intake tube, single bottle, full bottle shut-off at room temperature and 1524 m (5000 ft) elevation

Transfer Velocity (typical)

0.9 m/s (2.9 ft/s) with: 4.6 m (15 ft) vertical lift, 4.9 m (16 ft) of 3/8-in. vinyl intake tubing, 21 °C (70 °F) and 1524 m (5000 ft) elevation

Pump Flow Rate

4.8 L/min (1.25 gpm) at 1 m (3 ft) vertical lift with 3/8-in intake tube typical

Internal Clock

±1 second per day at 25 °C (77 °F)

Intake

Strainers: Choice of Teflon® and 316 stainless steel construction, or all 316 stainless steel in standard size, high velocity, and low profile for shallow depth applications

Purge: Air purged automatically before and after each sample; duration automatically compensates for varying intake line lengths

Rinse: Intake line automatically rinsed with source liquid prior to each sample, from 1 to 3 rinses

Retries or Fault: Sample collection cycle automatically repeated from 1 to 3 times if sample not obtained on initial attempt

**Subject to change without notice.*

Dimensions

The refrigeration compartment door of the AS950 All Weather Refrigerated Sampler is lockable (two keys are provided). The lid is also lockable for added security.

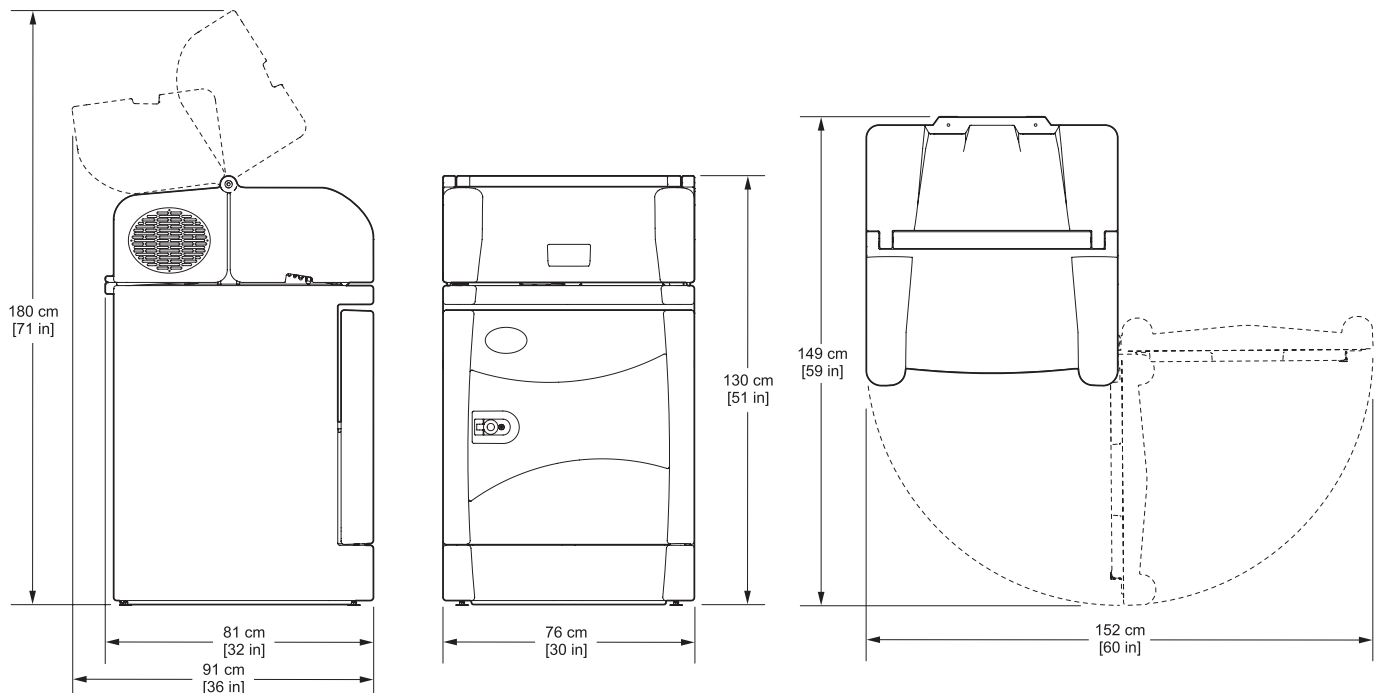

Ordering Information

AS950 All Weather Refrigerated Sampler (AWRS) Bundles

Includes AWRS base (115 Vac), sample bottle(s), vinyl intake tubing (25 ft.), and Teflon/stainless steel strainer. To order different combinations, please contact Hach Company.

- ASA.CXXX1X11XX** All Weather Refrigerated Sampler with AS950 controller; includes 21-L (5.5 gal) PE container and full bottle shut off
- ASA.CXXX1X31XX** All Weather Refrigerated Sampler with AS950 Controller; includes 4 10-L (2.5 gal) PE containers and distributor arm
- ASA.CXXX1X41XX** All Weather Refrigerated Sampler with AS950 Controller; includes 24 1-L PE containers and distributor arm

Bottle Options

- 6559** 2.5 Gallon Glass, with Teflon-lined cap
- 1918** 2.5 Gallon Polyethylene, with cap
- 6494** 5.5 Gallon Polyethylene, with cap
- 2318** Set of (2) 2.5 Gallon Glass, with Teflon-lined caps
- 2316** Set of (2) 2.5 Gallon Polyethylene, with caps
- 2317** Set of (4) 2.5 Gallon Glass, with Teflon-lined caps
- 2315** Set of (4) 2.5 Gallon Polyethylene, with caps
- 657** Set of (8) 2.3 Liter Polyethylene, with caps
- 1118** Set of (8) 1.9 Liter Glass, with Teflon-lined caps
- 9493000** Set of (12) 2 Liter Polyethylene, with caps
- 737** Set of (24) 1 Liter Polyethylene, with caps
- 732** Set of (24) 350 mL Glass, with Teflon-lined caps

Bottle Accessories

- 1511** Bottle Tray for 24 and 8 bottle sets
- 1322** Retainer for (24) 1 Liter Polyethylene and (8) bottle sets
- 1056** Retainer for (24) 350 mL Glass bottle sets
- 3527** Extension Tube for 6559 and 1918 Containers
- 8838** Composite Tube Support for all Composite Containers
- 8847** Full Bottle Shut-off for all Composite Containers

Distributors

- 8841** Distributor with Arm for 12 and 24 Bottle Configurations
- 8842** Distributor with Arm for 8 Bottle Configuration
- 8843** Distributor with Arm for 2 and 4 Bottle Configurations

Intake Tubing and Strainers

- 920** Vinyl Intake Tubing, 25 ft., 3/8-in. ID
- 922** Teflon-lined, Polyethylene Tubing, 25-ft., 3/8-in. ID (requires Connector Kit, Prod. No. 2186)
- 926** Strainer, Teflon/Stainless Steel
- 2070** Strainer, 316 stainless steel
- 2071** Strainer, for shallow depth applications, 316 stainless steel
- 2186** Connector Kit, for Teflon-lined polyethylene tubing
- 4652** Strainer, high velocity and shallow depth

Pump Tubing

- 4600-15** Pump Tubing, 15 ft.
- 4600-50** Pump Tubing, 50 ft.
- 8888** Pump Tube Insert
- 9501400** Pump Tube Insert, Non-contact liquid detect

Factory Installed Options (contact sales representative)

Two Sensor Ports

Accepts Hach digital Differential pH, Hach digital AV9000 analyzer with submerged area velocity flow and/or Hach digital US9000 ultrasonic level sensors

Rain/RS485 Port

Accepts Hach Rain Gauge (not included) or can be used as RS485 communications

Non-Contact Liquid Detect

Sample volume accuracy for applications that require complete tubing replacement

Inputs/Outputs

- 9494500** IO9001 Module (connects through auxiliary port) Includes 1 relay (high voltage).
- 9494600** IO9004 Module (connects through auxiliary port) Includes multiple 0/4-20 mA outputs and inputs for recorded measurements and to receive measurements from external instruments, four low voltage, contact closure, and four relays controlled by alarms.

Accessories

- 6613100** Anchor Kit Set
- 9504700** USB Cable, A to A

HACH COMPANY World Headquarters: Loveland, Colorado USA

United States: 800-227-4224 tel 970-669-2932 fax orders@hach.com

Outside United States: 970-669-3050 tel 970-461-3939 fax int@hach.com

hach.com

Printed in U.S.A.

©Hach Company, 2014. All rights reserved.

In the interest of improving and updating its equipment, Hach Company reserves the right to alter specifications to equipment at any time.



Be Right™